

# FICHAS DE LECTURA

## LIBRO: LA CALLE 25



### HABILIDADES QUE SE DESARROLLAN:

- Académicas funcionales
- Autodirección
- Comunicación
- Ocio y tiempo libre

# FICHA 1

**LA CALLE 25**  
**CAPÍTULO 8: LA TAHONA**

**1. ¿Qué es una Tahona?**



Una farmacia



Una panadería



Una pescadería



2. ¿Desde qué lugar fueron Javier y Mateo a la



Tahona?



Desde la  
librería

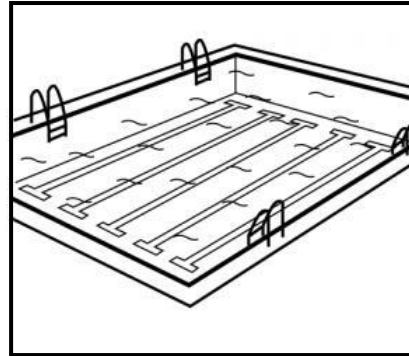

Desde la piscina



Desde la  
cafetería



3. Según Mateo, ¿qué se vende en la Tahona, que es



famoso en el mundo entero?

-----

-----



4. ¿Le gustó a Javier el bizcocho de limón?

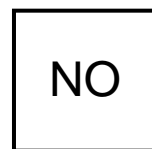
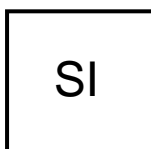

5. La pastelera era...

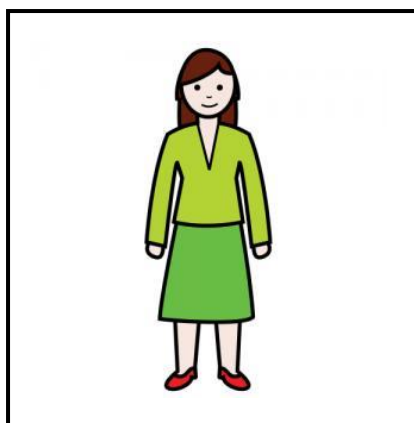

Joven

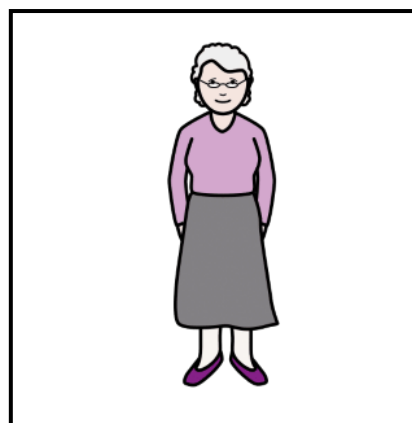

Mayor



6. ¿Cómo se llamaba la pastelera?

Ana

Lucia

María



7. ¿A qué olía la pastelera?

(tienes que señalar más de 1 respuesta correcta)

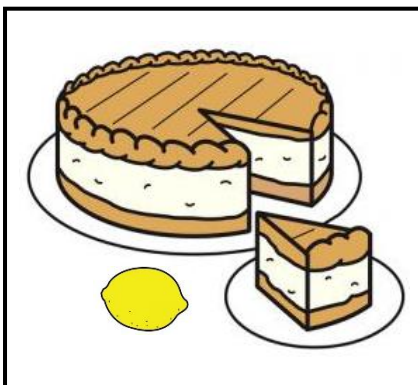

A pastel de limón

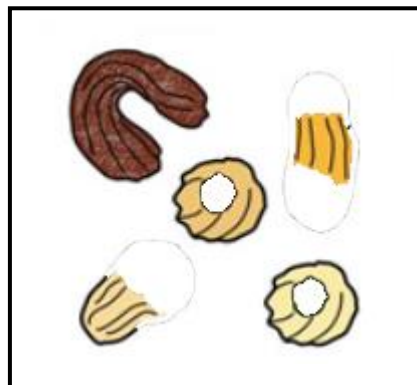

A pastas de nata

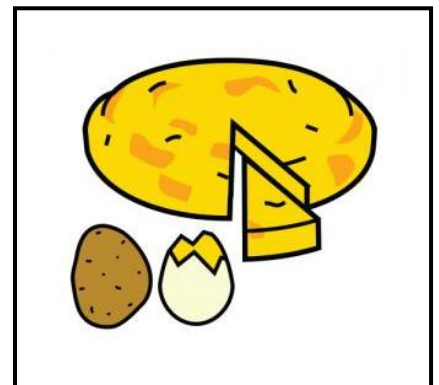

A tortilla de patata



## 8. Dibuja o escribe lo que más te gusta comer



de lo que hay en una panadería

A large, empty rectangular box with a black border, intended for the student to draw or write their answer.

# FICHA 2



**ACTIVIDAD 1**

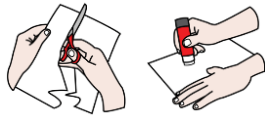

Recorta y pega los alimentos que se venden en la tahona

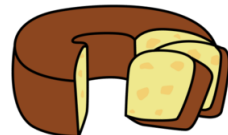
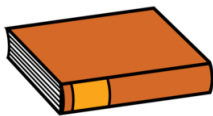
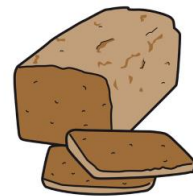
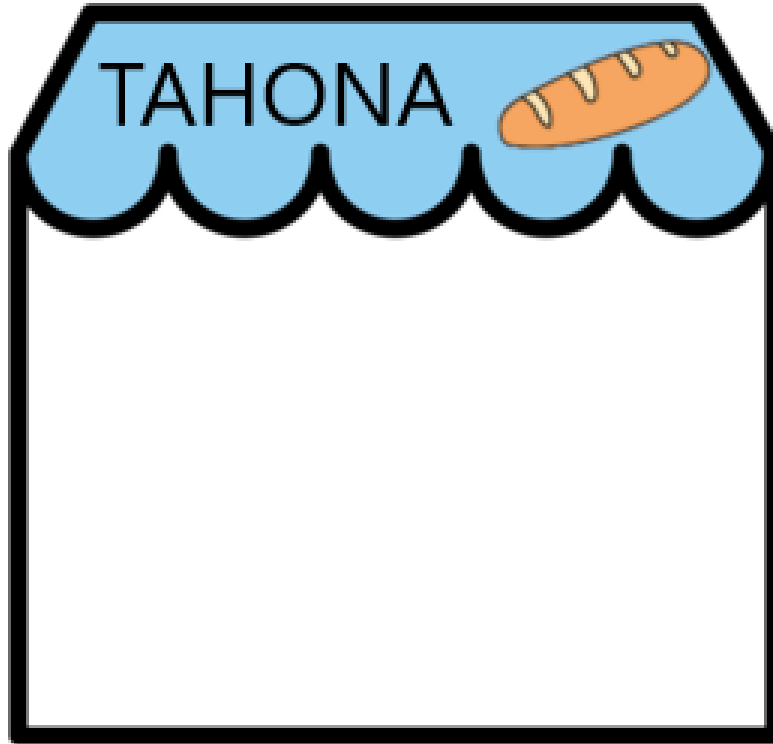

**ACTIVIDAD 2**



Pinta los pasteles  
del color de las frutas

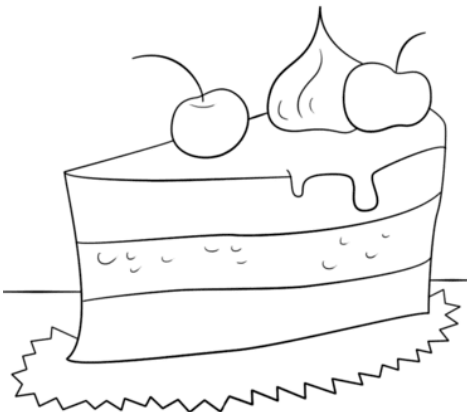
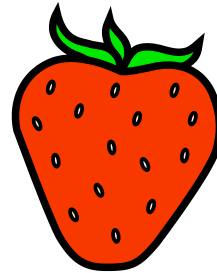
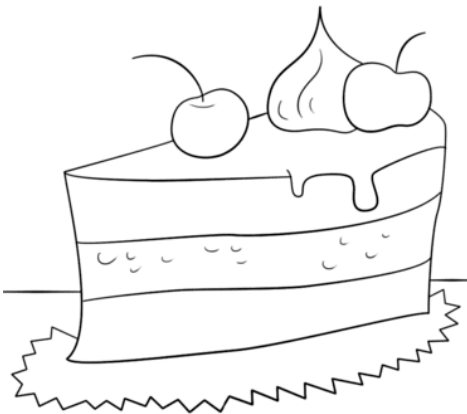
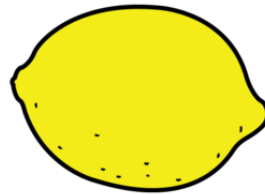
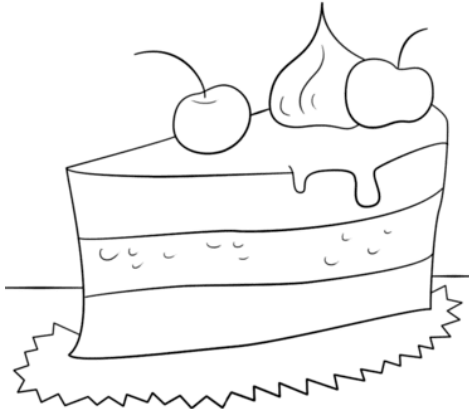

**ACTIVIDAD 3**



Decora la tarta como tú quieras



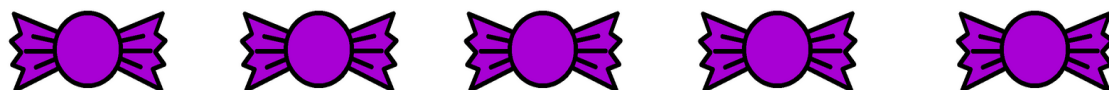
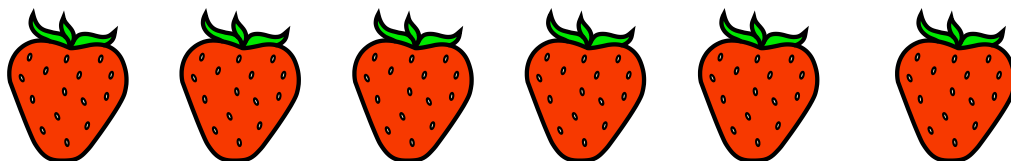

zorionak!!

**ACTIVIDAD 4**

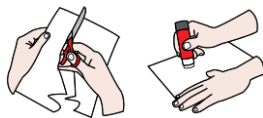

Recorta y pega su gorro al lado de cada persona

